

MCTRL660 PRO

Independent Controller



User Manual

Change History

Version	Release Date	Description
V1.4.0	2022-03-31	<ul style="list-style-type: none">• Optimized the document content.• Changed the document style.
V1.3.0	2019-03-04	<ul style="list-style-type: none">• Added the backup & restore function for Web control.• Changed the location of color depth function on Web control UI.• Added the following functions for home screen:<ul style="list-style-type: none">– The standby button will be disabled after the home screen is locked.– Display the color depth of video source.– Display the custom sending card name.• Deleted the deep color loop mode adjustment function.• Changed the value range of the hue parameter in the image settings to –180 to +180.
V1.2.0	2019-01-25	Updated the appearance and dimensions diagrams.
V1.1.0	2018-12-03	<ul style="list-style-type: none">• Optimized the description of ultra-high color depth input.• Optimized the description of individual gamma adjustment for RGB.• Optimized the description of low latency.
V1.0.0	2018-09-26	First release

Contents

1 Overview	1
1.1 Introduction.....	1
1.2 Features.....	1
2 Appearance	2
3 Applications	5
4 Cascade Devices.....	7
5 Home Screen	8
5.1 Sending Card Mode	8
5.2 Fiber Converter Mode.....	9
6 Menu Operations	11
6.1 Quick Screen Configuration.....	11
6.1.1 Step 1: Set Input Source.....	11
6.1.2 Step 2: Set Input Resolution	11
6.1.3 Step 3: Set Input Bit Depth.....	12
6.1.4 Step 4: Quickly Configure the Screen.....	13
6.2 Brightness Adjustment.....	14
6.3 Screen Settings	14
6.3.1 Quick Configuration.....	14
6.3.2 Advanced Configuration.....	14
6.3.3 Auto Configuration.....	15
6.3.4 Image Offset.....	16
6.4 Display Control.....	16
6.5 Image Mirroring.....	16
6.6 Backup and Restore.....	19
6.7 Advanced Settings.....	19
6.7.1 Mapping Function	19
6.7.2 Load Cabinet Configuration Files.....	20
6.7.3 Set Alarm Thresholds.....	20
6.7.4 Image Settings	20
6.7.5 Save to RV Card.....	21
6.7.6 Redundancy Settings.....	21
6.7.7 Presets	21
6.7.8 Input Backup.....	21
6.7.9 Low latency.....	22
6.8 System Settings.....	22
6.9 Communication Settings.....	23
6.10 Working Mode.....	23
6.11 Language.....	24
7 Operations on PC.....	25
7.1 Individual Gamma Adjustment for RGB.....	25
7.2 Operations on Web Page.....	25
7.2.1 Environment Configuration.....	26
7.2.2 Applications.....	26
7.3 Software Operations on PC.....	27
7.3.1 NovaLCT.....	27
7.3.2 SmartLCT.....	27
7.4 Firmware Update	28
7.4.1 NovaLCT.....	28
7.4.2 SmartLCT.....	28
7.5 Sending Card Name Customization.....	28
8 Specifications	30

1 Overview

1.1 Introduction

The MCTRL660 PRO is a professional controller developed by NovaStar. A single controller supports resolutions up to 1920x1200@60Hz. Supporting image mirroring, this controller can present a variety of images and bring an amazing visual experience to users.

The MCTRL660 PRO can work as a sending card and a fiber converter, and supports switching between the two modes, meeting more diversified market demands.

The MCTRL660 PRO is stable, reliable and powerful, dedicated to providing users with an ultimate visual experience. It can be mainly used in the rental and fixed installation applications, such as concerts, live events, security monitoring, Olympic Games, various sports centers, and much more.

1.2 Features

- Inputs
 - 1x 3G-SDI
 - 1x HDMI 1.4a
 - 1x SL-DVI
- 6x Gigabit Ethernet outputs, 2x optical outputs
- 8-bit, 10-bit and 12-bit inputs
- Image mirroring

Multi-angle image mirroring options allow for more cool and dazzling stage effects.
- Low latency

When low latency and input source sync are enabled, and cabinets are connected vertically, the delay between the input source and receiving card can be reduced to one frame.
- Individual gamma adjustment for RGB

For 10-bit or 12-bit inputs, this function can individually adjust the red gamma, green gamma and blue gamma to effectively control image non-uniformity in low grayscale conditions and white balance offset, allowing for a more realistic image.
- Pixel level brightness and chroma calibration

Work with NovaStar's high-precision calibration system to calibrate the brightness and chroma of each pixel, effectively removing brightness differences and chroma differences, and enabling high brightness consistency and chroma consistency.
- Input monitoring
- One-click backup and restore
- Screen configuration on web
- Cascading of up to 8 MCTRL660 PRO devices

2 Appearance

Front Panel

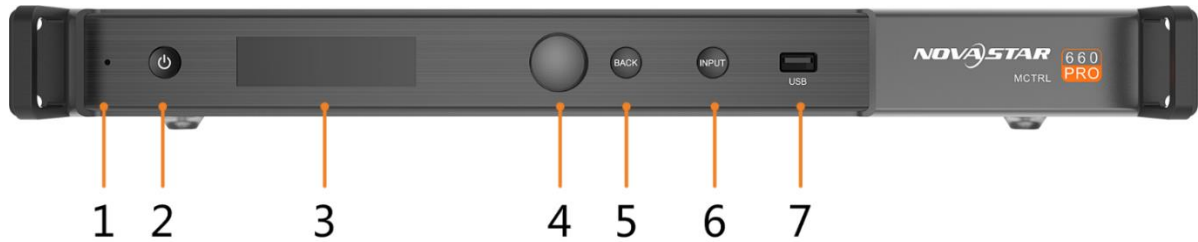

No.	Name	Description
1	Running Indicator	<ul style="list-style-type: none"> Green: The device is running normally. Red: Standby
2	Standby Button	Power on or off the device.
3	OLED Screen	Display the device status, menus, submenus and messages.
4	Knob	Select menus, adjust parameters, and confirm operations.
5	BACK	Go back to the previous menu or exit the current operation.
6	INPUT	Used to select the input
7	USB	Used to update the firmware

Rear Panel



Type	Name	Description
Input	DVI IN	1x SL-DVI input <ul style="list-style-type: none"> Max resolution: 1920x1200@60Hz Min resolution: 800x600@60Hz Custom resolutions supported <ul style="list-style-type: none"> Max width: 3840 pixels (3840x600@60Hz) Max height: 3840 pixels (800x3840@30Hz) HDCP 1.3 compliant Supported standard resolutions: <ul style="list-style-type: none"> 1024x768@(24/30/48/50/60/72/75/85/100/120)Hz 1280x1024@(24/30/48/50/60/72/75/85)Hz 1366x768@(24/30/48/50/60/72/75/85/100)Hz 1440x900@(24/30/48/50/60/72/75/85)Hz 1600x1200@(24/30/48/50/60)Hz 1920x1080@(24/30/48/50/60)Hz 1920x1200@(24/30/48/50/60)Hz 2560x960@(24/30/48/50)Hz 2560x1600@(24/30)Hz Do NOT support interlaced signal input.
	HDMI IN	1x HDMI 1.4a input <ul style="list-style-type: none"> Max resolution: 1920x1200@60Hz Min resolution: 800x600@60Hz

		<ul style="list-style-type: none"> • Custom resolutions supported Max width: 3840 pixels (3840×600@60Hz) Max height: 3840 pixels (800×3840@30Hz) • HDCP 1.4 compliant • Supported standard resolutions: 1024×768@(24/30/48/50/60/72/75/85/100/120)Hz 1280×1024@(24/30/48/50/60/72/75/85)Hz 1366×768@(24/30/48/50/60/72/75/85/100)Hz 1440×900@(24/30/48/50/60/72/75/85)Hz 1600×1200@(24/30/48/50/60)Hz 1920×1080@(24/30/48/50/60)Hz 1920×1200@(24/30/48/50/60)Hz 2560×960@(24/30/48/50)Hz 2560×1600@(24/30)Hz • Do NOT support interlaced signal input.
	3G-SDI IN	<ul style="list-style-type: none"> • SMPTE ST 425-1 Level A & B, SMPTE ST 274, ST 296, ST 295 compliant • Max input resolution: 1920×1080@60Hz • Note: Do NOT support input resolution and bit depth settings.
Output	RJ45×6	6x RJ45 Gigabit Ethernet ports <ul style="list-style-type: none"> • Max loading capacity per port: <ul style="list-style-type: none"> – 8bit: 650,000 pixels – 10/12bit: 325,000 pixels • Support redundancy between Ethernet ports.
	OPT1 OPT2	2x 10G optical ports <ul style="list-style-type: none"> – Single-mode twin-core fiber: Support LC optical connectors; wavelength: 1310 nm; transmission distance: 10 km; OS1/OS2 recommended – Dual-mode twin-core fiber: Support LC optical connectors; wavelength: 850 nm; transmission distance: 300 m; OM3/OM4 recommended • The maximum loading capacity of a single optical port equals to that of 6 Gigabit Ethernet ports. • 2x OPT inputs/outputs OPT1 is the main input or output port and corresponds to the 6 Gigabit Ethernet ports OPT2 is the backup input or output port of OPT1. • In sending card mode, either the 2 optical ports or the 6 Gigabit Ethernet ports can work as output ports to output the same image. • In fiber converter mode, when the optical ports work as input ports, the 6 Gigabit Ethernet ports work as output ports. When the 6 Gigabit Ethernet ports work as input ports, the optical ports work as output ports.
	DVI LOOP	DVI loop through
	HDMI LOOP	HDMI loop through. Support HDCP 1.3 loop through encryption.
	3G-SDI LOOP	SDI loop through
Control	ETHERNET	Connect to the control computer.

	USB IN-OUT	<ul style="list-style-type: none"> • IN: 1x type-B USB 2.0, used as the input port to cascade devices or connect to PC for device debug • OUT: 1x type-A USB 2.0, used as the output port to cascade devices. Up to 8 devices can be cascaded.
	GENLOCK IN-LOOP	<p>A pair of Genlock signal connectors. Support Bi-Level, Tri-Level and Black burst.</p> <ul style="list-style-type: none"> • IN: Accept the sync signal. • LOOP: Loop the sync signal.
Power	100 V–240 V AC	
Power switch	ON/OFF	

XI'AN NOVASTAR TECH CO., LTD

3 Applications

The MCTRL660 PRO can work as a sending card and fiber converter, meeting multiple application needs.

Application 1: Sending Card Mode

On the OLED menu screen, choose **Working Mode > Sending Card**. This mode uses the optical ports or Gigabit Ethernet ports to output video signals.

Figure 3-1 Application of sending card mode

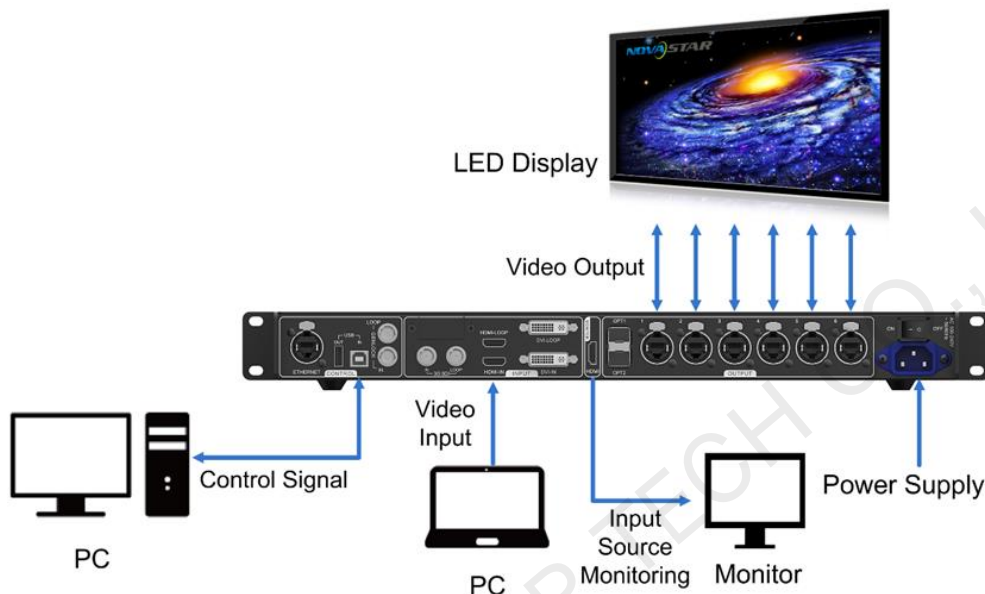

Application 2: Fiber Converter Mode

Set different working modes for the two devices respectively, as shown in Figure 3-2. Device 2 uses the optical ports (for input/output) and Gigabit Ethernet ports (for output/input) to realize optical and electric signal conversion, which allows for long-distance signal transmission.

Figure 3-2 Application of fiber converter mode

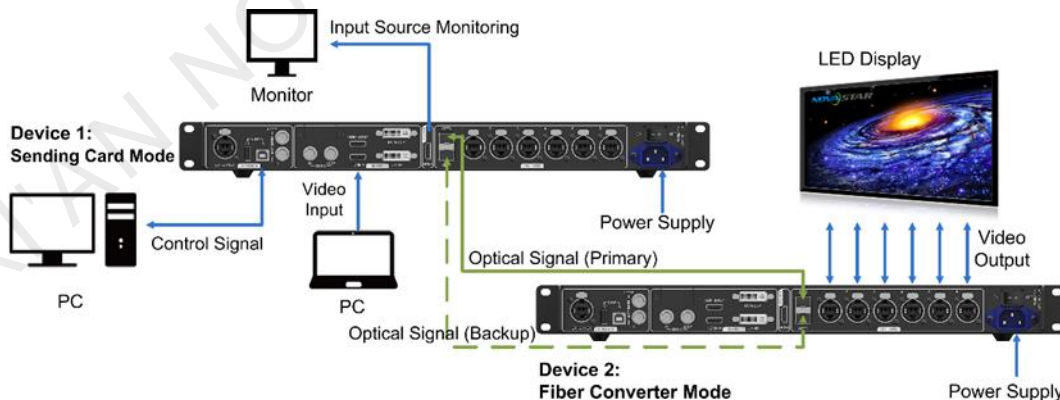

Application 3: Dual Output Mode

Set different working modes for the two devices respectively, as shown in Figure 3-3. Device 1 uses the optical ports and Gigabit Ethernet ports to output images at the same time.

Figure 3-3 Application of dual output mode

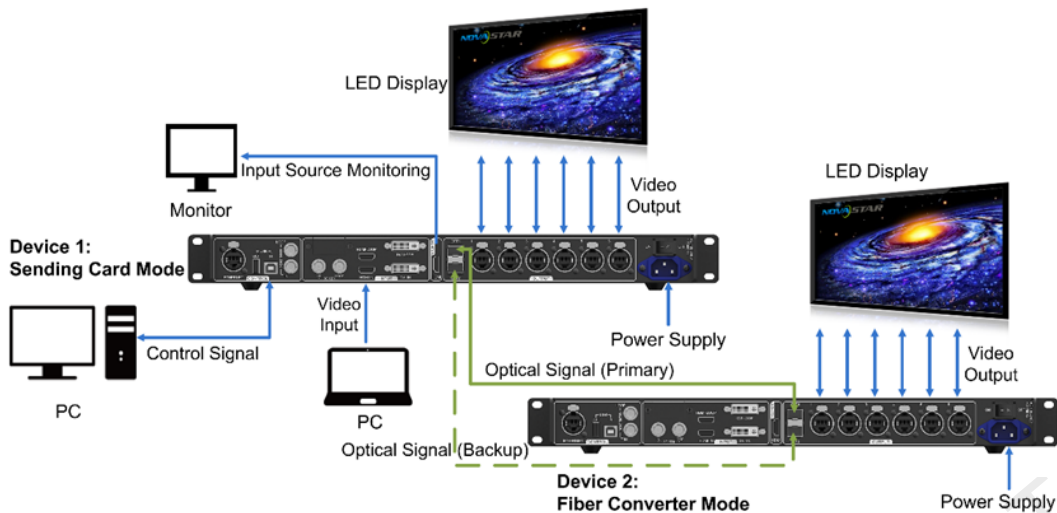

4 Cascade Devices

- The control computer controls multiple MCTRL660 PRO devices.

Cascade the MCTRL660 PRO devices via their USB IN and USB OUT ports. Up to 8 devices can be cascaded.

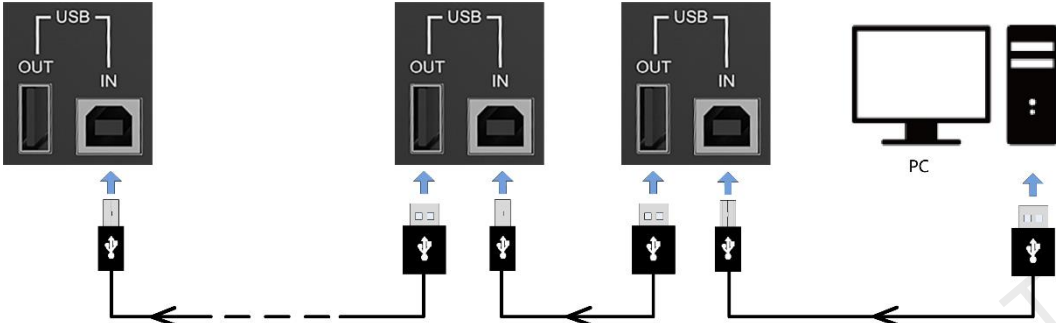

- Multiple MCTRL660 PRO devices output image simultaneously.

Cascade the MCTRL660 PRO devices via their GENLOCK IN and GENLOCK LOOP connectors. Up to 8 devices can be cascaded.

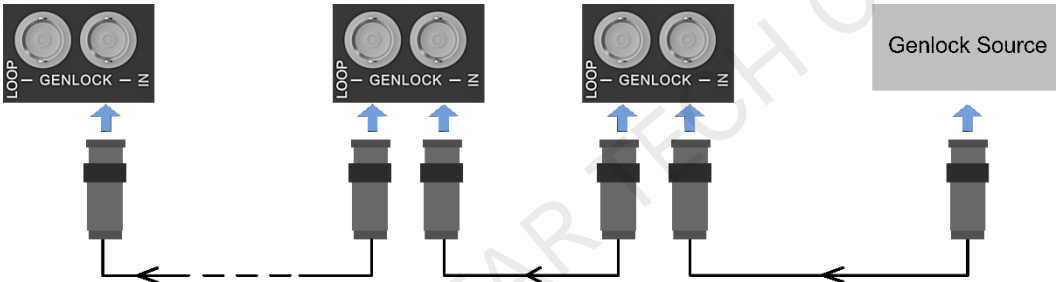



5 Home Screen

5.1 Sending Card Mode

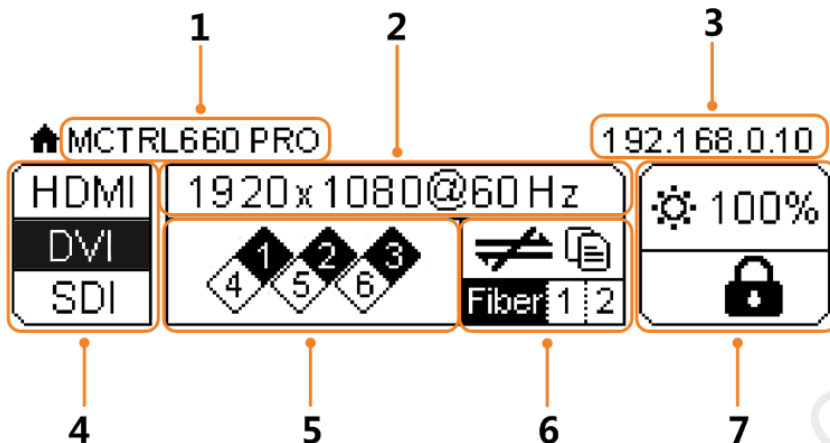
In the sending card mode, the home screen of the MCTRL660 PRO is shown below.



No.	Description
1	Device name
2	<ul style="list-style-type: none"> Alternatively display the resolution and color depth of the current input source when there are input sources accessed. Display the display control status when there is no input source.
3	Alternatively display the device IP address and sending card name. The sending card name can be customized in NovaLCT. See 7.5 Sending Card Name Customization .
4	Different types of video sources and their connection statuses
5	Ethernet port connection status <ul style="list-style-type: none"> Always on: The Ethernet port connection works and the port serves as primary Off: No Ethernet cable is connected or the connection does not work. A mark (not flashing) on top corner of icon: The Ethernet port is in redundancy status, but the redundancy has not taken effect. A mark (flashing) on top corner of icon: The Ethernet port is in redundancy status and the redundancy has taken effect.
6	Operating status  The system configuration file is backed up / not backed up.
	 Voltage alarm / Temperature alarm / Voltage and temperature alarms



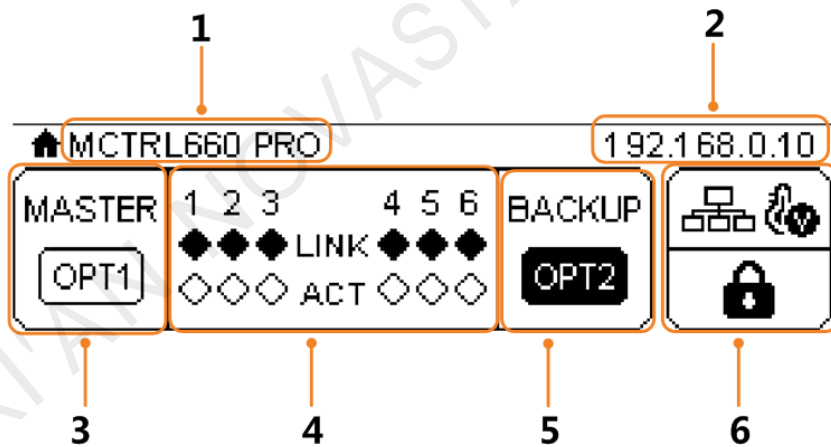

No.	Description
	<p>Optical port connection status:</p> <ul style="list-style-type: none"> Always on: The optical port connection works and the port serves as primary. Off: No optical fiber cable is connected or the connection does not work.
	<p>Control port connection status: Not connected / USB connected / Ethernet connected / GENLOCK connected</p> <p>When the USB port, Ethernet port and GENLOCK connector are all connected to the control computer, their priority in control is GENLOCK > USB > ETHERNET.</p>
7	<p>LED screen brightness</p>
	<p>Front panel buttons locked / unlocked</p> <p>Hold down the knob and BACK button simultaneously for 3s to lock or unlock all the front panel buttons. After the buttons are locked, all the button operations will not take effect and  appears on the home screen.</p>

5.2 Fiber Converter Mode

In the fiber converter mode, the home screen of the MCTRL660 PRO is shown below.



No.	Description
1	Device name
2	Alternatively display the device IP address and sending card name. The sending card name can be customized in NovaLCT. See 7.5 Sending Card Name Customization .
3	OPT1 is the primary input or output optical port, corresponding to the 6 Gigabit Ethernet ports. <ul style="list-style-type: none"> Always on: The optical port connection works. Off: No optical fiber cable is connected or the connection does not work.

No.	Description
4	1–6: Indicate Ethernet ports 1–6. <ul style="list-style-type: none"> • LINK: Ethernet port connection status <ul style="list-style-type: none"> – Always on: The Ethernet port connection works. – Off: No Ethernet cable is connected or the connection does not work. • ACT: Signal transmission status of Ethernet port <ul style="list-style-type: none"> – Flashing: The Ethernet port is transmitting signals. – Off: The Ethernet port is not transmitting signals.
5	OPT2 is the backup input or output port of OPT1. <ul style="list-style-type: none"> • Always on: The optical port connection works. • Off: No Ethernet cable is connected or the connection does not work.
6	 Normal voltage and temperature / Voltage alarm / Temperature alarm / Temperature and voltage alarms
	 Control port connection status: Not connected / USB connected / Ethernet connected When the USB port and Ethernet port are all connected to the control computer, their priority in control is USB > ETHERNET.
	 Front panel buttons locked / unlocked Hold down the knob and BACK button simultaneously for 3s to lock or unlock all the front panel buttons. After the buttons are locked, all the button operations will not take effect and  appears on the OLED screen.

6 Menu Operations

The MCTRL660 PRO is powerful and easy to use. You can quickly configure the LED screen to light it up and display the entire input source following the steps in 6.1 [Quick Screen Configuration](#). With other menu settings, you can further improve the LED screen display effect.

6.1 Quick Screen Configuration

Following the four steps below, namely Set Input Source > Set Input Resolution > Set Bit Depth > Quickly Configure the Screen, you can quickly light up the LED screen to display the entire input source.

6.1.1 Step 1: Set Input Source

Supported input sources include 3G-SDI, Single-Link DVI and HDMI 1.4a. Select an input source that matches the type of the inputted external video source.

Constraints:

- Only one input source can be selected at the same time.
- Interlaced SDI video sources do not support low latency.
- SDI video sources do not support the following functions:
 - Input source bit depth adjustment
 - Preset resolution
 - Custom resolution
 - Image mirroring

Figure 6-1 Input source

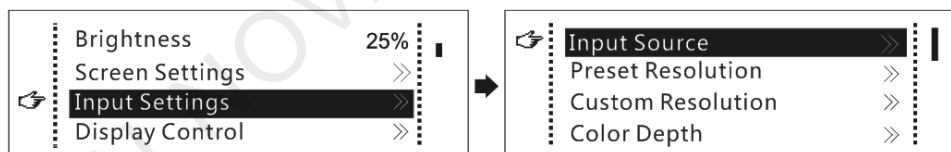

Step 1 On the home screen, press the knob to enter the main menu.

Step 2 Choose **Input Settings** > **Input Source** to enter its submenu.

Step 3 Select the target input source and press the knob to enable it.

6.1.2 Step 2: Set Input Resolution

Constraints: SDI input sources do not support input resolution settings.

The input resolution can be set through either of the following methods.

Method 1: Select a Preset Resolution

Select an appropriate preset resolution and refresh rate as the input resolution.

Figure 6-2 Preset resolution

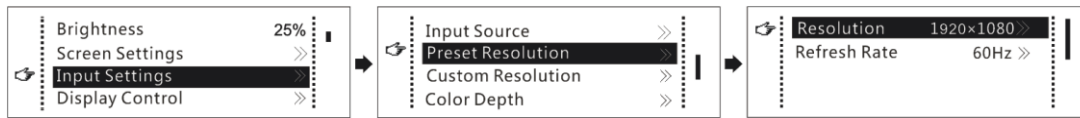

- Step 1 On the home screen, press the knob to enter the main menu.
- Step 2 Choose **Input Settings** > **Preset Resolution** to enter its submenu.
- Step 3 Select a resolution and refresh rate, and press the knob to apply them.

Input Source	Available Standard Resolution Presets
HDMI 1.4/SL-DVI	<ul style="list-style-type: none"> • 1024x768@(24/30/48/50/60/72/75/85/100/120)Hz • 1280x1024@(24/30/48/50/60/72/75/85)Hz • 1366x768@(24/30/48/50/60/72/75/85/100)Hz • 1440x900@(24/30/48/50/60/72/75/85)Hz • 1600x1200@(24/30/48/50/60)Hz • 1920x1080@(24/30/48/50/60)Hz • 1920x1200@(24/30/48/50/60)Hz • 2560x960@(24/30/48/50)Hz • 2560x1600@(24/30)Hz

Method 2: Customize a Resolution

Customize a resolution by setting a custom width, height and refresh rate.

Figure 6-3 Custom resolution

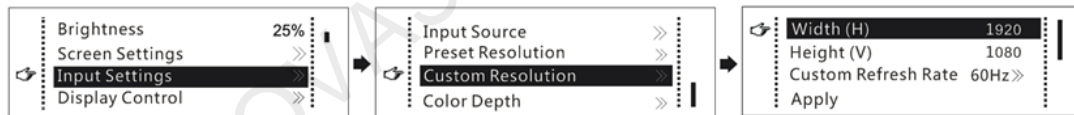

- Step 1 On the home screen, press the knob to enter the main menu.
- Step 2 Choose **Input Settings** > **Custom Resolution** to enter its submenu and set the screen width, height and refresh rate.
- Step 3 Select **Apply** and press the knob to apply the custom resolution.

6.1.3 Step 3: Set Input Bit Depth

Set the bit depth of input source, including 8bit, 10bit and 12bit.

Constrains: SDI input sources do not support bit depth adjustment.

Figure 6-4 Bit depth



- Step 1 On the home screen, press the knob to enter the main menu.

Step 2 Choose **Input Settings > Color Depth** to enter its submenu, select a color depth, and press the knob to apply it.

Table 6-1 Input bit depth adjustment

Bit Depth	Description
8bit	The loading capacity of the device will not be reduced.
10bit	The loading capacity of the device will be reduced by half. The bit depth must be set.
12bit	The loading capacity of the device will be reduced by half. The bit depth must be set.

6.1.4 Step 4: Quickly Configure the Screen

Follow the steps below to complete quick screen configuration.

Figure 6-5 Quick configuration

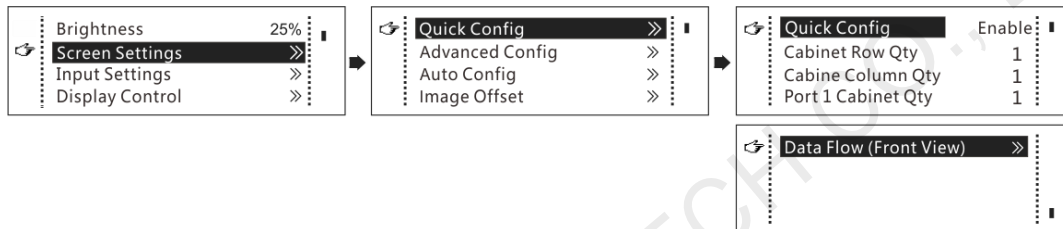

Step 1 On the home screen, press the knob to enter the main menu.

Step 2 Choose **Screen Settings > Quick Config** to enter its submenu and set the parameters.

- Set **Cabinet Row Qty** and **Cabinet Column Qty** (numbers of cabinet rows and columns to be loaded) according to the actual situation of the screen.
- Set **Port1 Cabinet Qty** (number of cabinets loaded by Ethernet port 1). The device has restrictions on the number of cabinets loaded by the Ethernet ports. See Note a).
- Set **Data Flow (Front View)** of the screen. See Note c), d), and e).

Notes	
a). If n ports are used to load the screen, the number of cabinets loaded by each of the first $(n-1)$ ports must be the same and the integral multiple of the number of cabinet rows or columns, and it must be greater than or equal to the number of cabinets loaded by the last port.	Example: If all the 6 Ethernet ports are used to load the screen, the number of cabinets loaded by ports 1–5 must be the same and the integral multiple of the number of cabinet rows or columns. Therefore, you need to set only the number of cabinets loaded by port 1 according to the actual situation. The number of cabinets loaded by port 6 must be less than or equal to the number of cabinets loaded by port 1.
b). For irregular screens, NovaLCT software must be connected to configure the screen.	
c). During data flow settings, you can rotate the knob to select a target data flow pattern.	
d). During data flow settings, ensure that the cabinets loaded by each Ethernet port are connected one by one in the same direction.	
e). During data flow settings, ensure that Ethernet port 1 is at the beginning position of the whole physical connection.	

6.2 Brightness Adjustment

This function allows you to adjust the LED screen brightness in an eye-friendly way according to the current ambient brightness. Besides, appropriate screen brightness can extend the service life of the LED screen.

Figure 6-6 Brightness adjustment

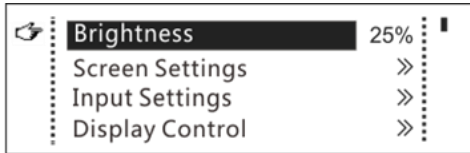

- Step 1 On the home screen, press the knob to enter the main menu screen.
- Step 2 Select **Brightness** and press the knob to confirm the selection.
- Step 3 Rotate the knob to adjust the brightness value. You can see the adjustment result on the LED screen in real time. Press the knob to apply the brightness you set when you are satisfied with it.

6.3 Screen Settings

Configure the LED screen to ensure the screen can display the entire input source normally.

Screen configuration methods include quick, advanced and automatic configurations.

Constraints:

- The three methods cannot be enabled at the same time.
- After the screen is configured in NovalCT, do not use any of the methods on the MCTRL660 PRO to configure the screen again.

6.3.1 Quick Configuration

Configure the whole LED screen uniformly and quickly. See [6.1 Quick Screen Configuration](#).

6.3.2 Advanced Configuration

Set parameters for each Ethernet port, including number of cabinet rows and columns (**Cabinet Row Qty** and **Cabinet Column Qty**), horizontal offset (**Start X**), vertical offset (**Start Y**), and data flow.

Figure 6-7 Advanced configuration

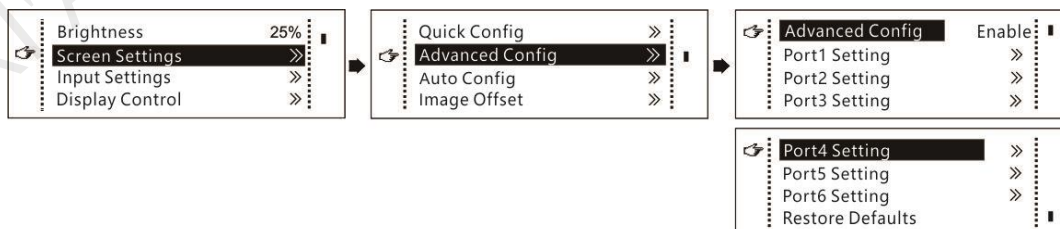

- Step 1 On the home screen, press the knob to enter the main menu.
- Step 2 Choose **Screen Settings** > **Advanced Config** to enter its submenu.
- Step 3 Enable **Advanced Config**, select an Ethernet port, set the parameters for it, and apply the settings.
- Step 4 Select the next Ethernet port to continue setting until all the Ethernet ports are set.

6.3.3 Auto Configuration

Note:

Each Ethernet port must load only a whole row or column of cabinets.

Figure 6-8 Each Ethernet port loading only one row of cabinets

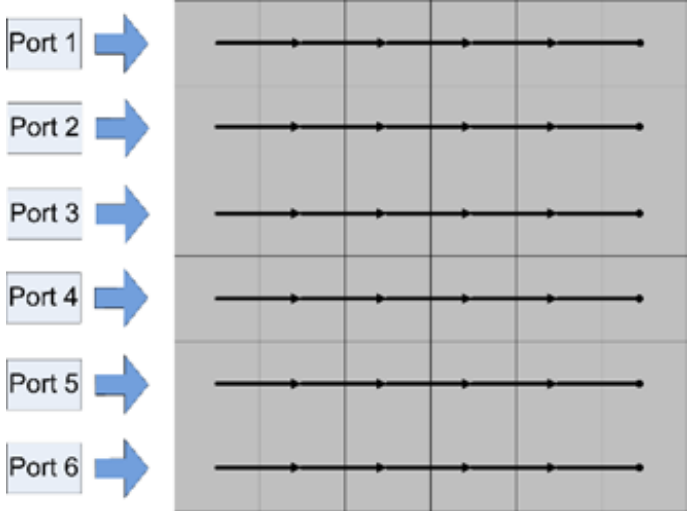

Figure 6-9 Each Ethernet port loading only one column of cabinets

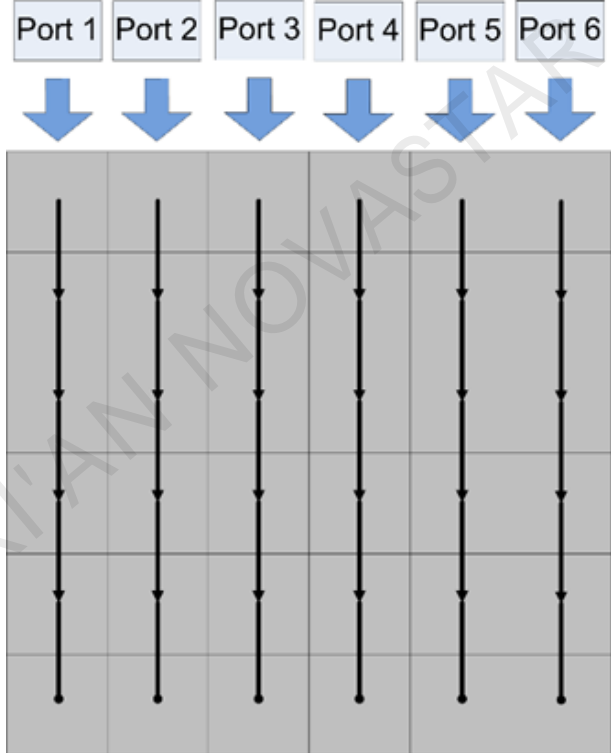
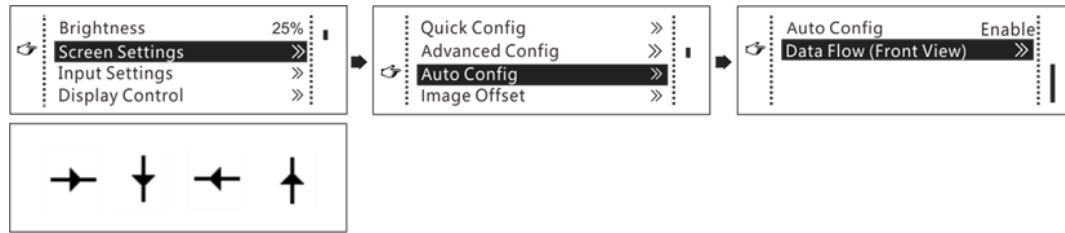

Figure 6-10 Auto configuration



- Step 1 On the home screen, press the knob to enter the main menu.
- Step 2 Choose **Screen Settings** > **Auto Config** to enter its submenu.
- Step 3 Enable **Auto Config** and select a data flow.

6.3.4 Image Offset

After configuring the screen, adjust the horizontal and vertical offsets (**Start X** and **Start Y**) of the overall display image to ensure it is displayed in the desired position.

Figure 6-11 Image offset



- Step 1 On the home screen, press the knob to enter the main menu.
- Step 2 Choose **Screen Settings** > **Image Offset** to enter its submenu.
- Step 3 Set the **Start X** and **Start Y** values.

6.4 Display Control

Control the display status on the LED screen.

Figure 6-12 Display control



- Normal: Display the content of the current input source normally.
- Black Out: Make the LED screen go black and do not display the input source. The input source is still being played in the background.
- Freeze: Make the LED screen always display the frame when frozen. The input source is still being played in the background.
- Test Pattern: Test patterns are used to check the display effect and pixel operating status. There are 8 test patterns, including pure colors and line patterns.

6.5 Image Mirroring

Mirror images displayed on the LED screen. You can disable mirroring, mirror the image from left to right or from top to bottom. The image mirroring is based on the entire output image.

Constraints:

- This function is disabled when the input source is SDI.
- Image mirroring and low latency cannot be enabled at the same time.

Figure 6-13 Image mirroring

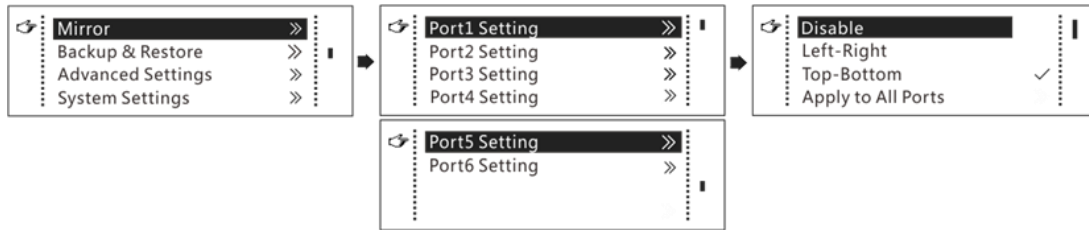

- Step 1 On the home screen, press the knob to enter the main menu.
- Step 2 Select **Mirror** and press the knob to enter its submenu.
- Step 3 Set the mirroring mode for the image loaded by the current Ethernet port.
- Step 4 (Optional) Select **Apply to All Ports** and press the knob. The mirroring settings will take effect on all other Ethernet ports automatically.

The mirroring effects are illustrated in the following figures.

Figure 6-14 Left-right mirroring of the image loaded by Ethernet port 1



As shown in [Figure 6-14](#), after you set the mirroring mode as left-right for Ethernet port 1, the entire image is mirrored horizontally, but only the Ethernet port 1 area displays the partial mirrored image.

Figure 6-15 Left-right mirroring of images loaded by Ethernet ports 1–2

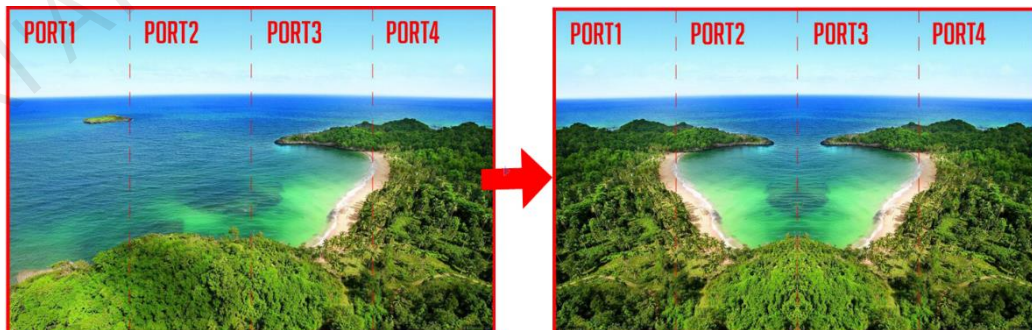

As shown in [Figure 6-15](#), after you set the mirroring mode as left-right for Ethernet ports 1–2, the entire image is mirrored horizontally, but only the areas of Ethernet ports 1–2 display the partial mirrored images.

Figure 6-16 Left-right mirroring of the entire image



As shown in [Figure 6-16](#), after you set the mirroring mode as left-right for Ethernet ports 1–4, the entire image is mirrored horizontally.

Figure 6-17 Top-bottom mirroring of the image loaded by Ethernet port 1



As shown in [Figure 6-17](#), after you set the mirroring mode as top-bottom for Ethernet port 1, the entire image is mirrored vertically, but only the Ethernet port 1 area displays the partial mirrored image.

Figure 6-18 Top-bottom mirroring of the entire image

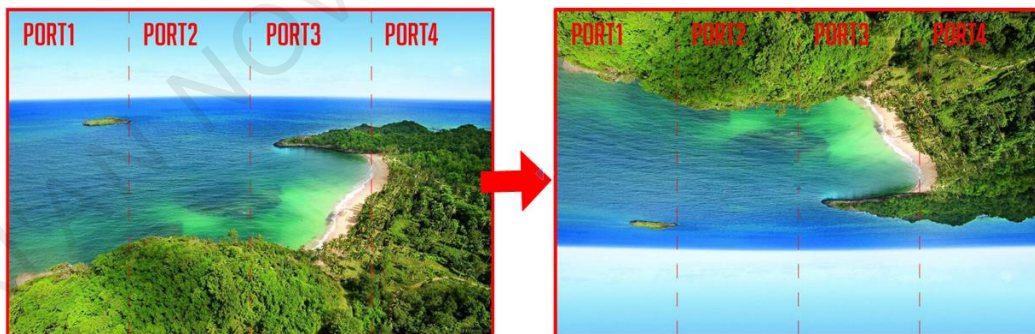

As shown in [Figure 6-18](#), after you set the mirroring mode as top-bottom for Ethernet ports 1–4, the entire image is mirrored vertically.

6.6 Backup and Restore

Figure 6-19 Backup and restore

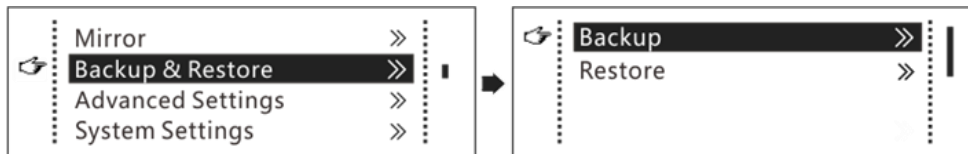

- Back up the system configuration to the controller.
- Restore the system configuration from the controller.
- Restore the receiving card configuration from the controller.
- Restore the sending card configuration from the controller.

Note:

System configuration includes configuration files of the sending card (namely the controller) and receiving cards.

6.7 Advanced Settings

6.7.1 Mapping Function

When this function is enabled, each cabinet of the screen will display the sequence number of the cabinet and the Ethernet port that loads the cabinet.

Figure 6-20 Mapping function

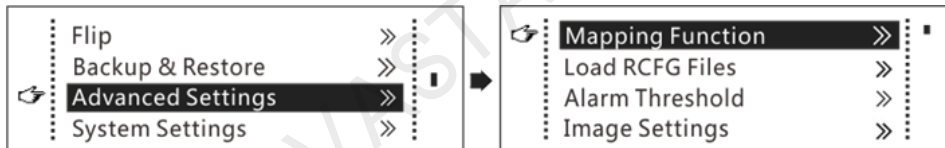

Example: "P:01" stands for the Ethernet port number and "#001" stands for the cabinet number.

Note

The receiving cards used in the system must support the Mapping function.

6.7.2 Load Cabinet Configuration Files

Before you begin: Save the cabinet configuration file (*.rcfgx or *.rcfg) to the local PC.

- Step 1 Run NovaLCT and choose **Tools > Controller Cabinet Configuration File Import**.
- Step 2 On the displayed page, select the currently used Ethernet port, click **Add Configuration File** to select and add a cabinet configuration file.
- Step 3 Click **Save the Change to HW** to save the change to the controller.

Figure 6-21 Importing configuration file of controller cabinet

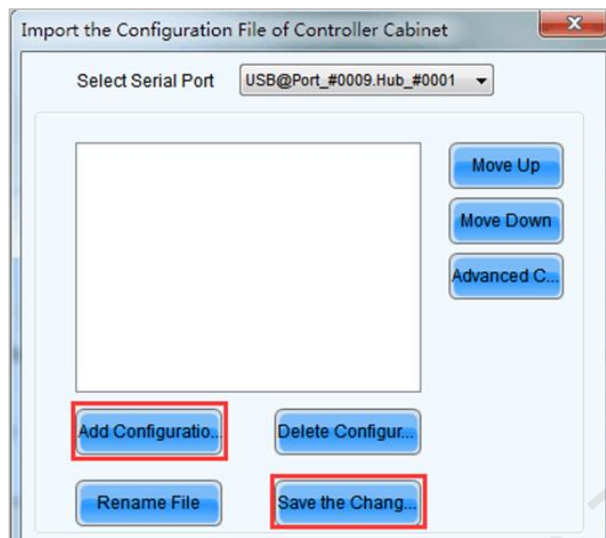



Note

Configuration files of irregular cabinets are not supported.

6.7.3 Set Alarm Thresholds

Set the alarm thresholds for device temperature and voltage. When a threshold is exceeded, its corresponding icon on the home screen will be flashing, instead of displaying the value.

- : Voltage alarm, icon flashing. Voltage threshold range: 3.5 V to 7.5 V
- : Temperature alarm, icon flashing. Temperature threshold range: -20°C to +85°C
- : Voltage and temperature alarms at the same time, icon flashing

Note

When there are no temperature or voltage alarms, the home screen will display the backup status.

6.7.4 Image Settings

Adjust the color of the output image. You can see the adjustment result on the LED screen in real time.

Table 6-2 Image parameters

Parameter	Description
Color temperature	Range: 4000 K to 9500 K; step: 100
Red/Green/Blue	Range: 0 to 255; step: 1

Gamma	Range: 1.0 to 4.0; step: 0.1
Contrast	Range: 0% to 100%; step: 1%
Saturation	Range: 0% to 100%; step: 1%
Hue	Range: -180 to +180; step: 1

6.7.5 Save to RV Card

By using this function, you can:

- Send and save the configuration information to the receiving cards, including brightness, color temperature, gamma and display settings.
- Overwrite the information saved to the receiving card earlier.
- Ensure that the data saved in the receiving cards will not be lost upon power failure of receiving cards.

6.7.6 Redundancy Settings

Set the controller as the primary or backup device. When the controller works as a backup device, set the data flow direction as opposite to that of the primary device.

Note

If the controller is set as the backup device, when the primary device fails, the backup device will immediately take over the work of the primary device, that is, the backup takes effect. After the backup takes effect, the target Ethernet port icons on the home screen will have marks on top flashing once every 1 second.

6.7.7 Presets

Choose **Advanced Settings > Presettings** to save current settings as a preset. Up to 10 presets can be saved.

- Save: Save current parameters as a preset.
- Load: Read back the parameters from a saved preset.
- Delete: Delete the parameters saved in a preset.

6.7.8 Input Backup

Set a backup video source for each primary video source. Other input video sources supported by the controller can be set as backup video sources.

After a backup video source takes effect, the video source selection is irreversible.

Primary Input	Backup Input
SDI	NULL/DVI/HDMI
DVI	NULL/SDI/HDMI
HDMI	NULL/DVI/SDI

6.7.9 Low latency

- Supports a low latency of less than 1 ms (when the start position of image is 0). Low latency is used to reduce the time delay between the input of video signal to the controller and the corresponding output. The loading width of a single Ethernet port should be no greater than 512 pixels when low latency function is enabled.
- Low latency cannot be enabled with any of the following functions at the same time.
 - Image mirroring
 - Interlaced SDI video sources
 - GENLOCK
- To use the low latency function, you must ensure that each Ethernet port loads the cabinets vertically during screen configuration, as shown in [Figure 6-22](#).

Figure 6-22 Ethernet port loading cabinets vertically

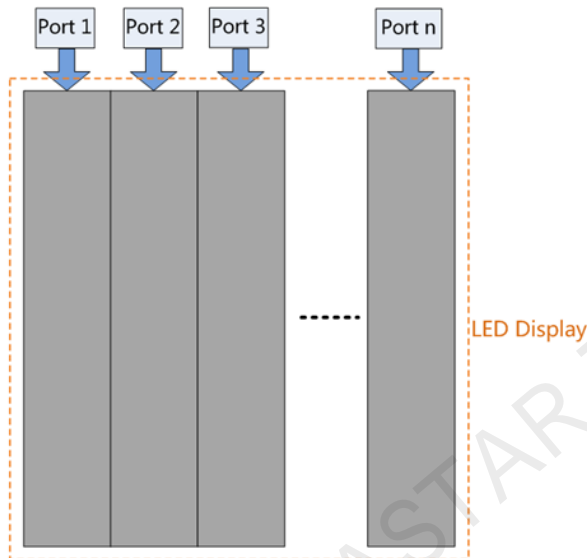

6.8 System Settings

Figure 6-23 System settings

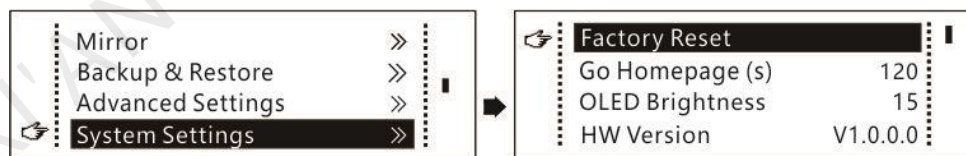

Factory Reset

Reset the controller parameters to factory settings.

Return to Home (s)

Set the time of staying on the current screen before going back to the home screen when no action is performed. The time range is 30s to 3600s.

OLED Brightness

Adjust the brightness of the OLED menu screen on the front panel. The brightness range is 6 to 15.

Hardware Version

Check the hardware version of the controller. If a new version is released, you can connect the controller to a PC to update the firmware programs in NovaLCT or SmartLCT.

6.9 Communication Settings

Set the communication mode and network parameters of the MCTRL660 PRO.

Figure 6-24 Communication mode

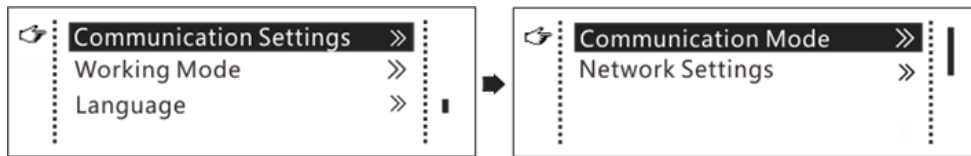

- Communication mode: Include USB preferred and Local Area Network (LAN) preferred.
The controller connects to PC via USB port and Ethernet port. If **USB Preferred** is selected, the PC prefers to communicate with the controller via the USB port, or else via the Ethernet port.
- The network settings can be done manually or automatically.
 - Manual settings include controller IP address and subnet mask.
 - Automatic settings can read the network parameters automatically.
- Reset: Reset the parameters to defaults.

6.10 Working Mode

The MCTRL660 PRO supports switching between the sending card mode and fiber converter mode.

Figure 6-25 Working mode

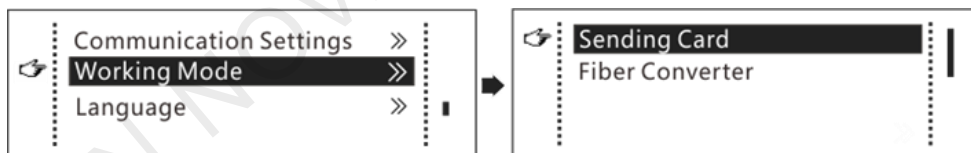

Sending Card Mode

On the OLED menu screen, set the working mode as **Sending Card**. Either the optical ports or the Gigabit Ethernet ports can work as output ports to output video signals. See [Application 1: Sending Card Mode](#). The home screen in the sending card mode is shown below.

Figure 6-26 Home screen in the sending card mode



Fiber Converter Mode

- Only communication settings and working mode settings are available.
- The temperature and voltage alarm thresholds keep the last settings.

On the OLED menu screen, set the working mode as **Fiber Converter**. The optical ports (for input/output) and Gigabit Ethernet ports (for output/input) are used to realize conversion between optical and electric signals. See [Application 2: Fiber Converter Mode](#). The home screen in the fiber converter mode is shown below.

Figure 6-27 Home screen in the fiber converter mode

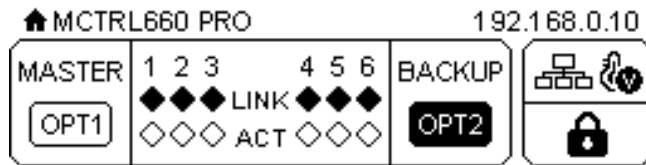

6.11 Language

Change the system language of the device.

7 Operations on PC

7.1 Individual Gamma Adjustment for RGB

The device supports individual gamma adjustment for RGB when the input bit depth is 10-bit or 12-bit. This function can effectively control image non-uniformity in low grayscale conditions and white balance offset to improve image quality.

- Step 1 Run NovaLCT, click **Screen Configuration**, choose the current operation communication port and click **Next**.
- Step 2 On the **Sending Card** tab page, select the corresponding input bit depth and click **Set**.
- Step 3 On the home page of NovaLCT, choose **Brightness > Manually Adjustment**.
- Step 4 Under Advanced Settings, choose **Gamma > Custom Gamma Adjustment** and click **Configuration** to enter the **Gamma Adjustment** page.
- Step 5 Adjust Red Gamma, Green Gamma and Blue Gamma.
- Step 6 Click **Send**.
- Step 7 Close the Gamma Adjustment page. On the Brightness Adjustment page, click Save to HW.

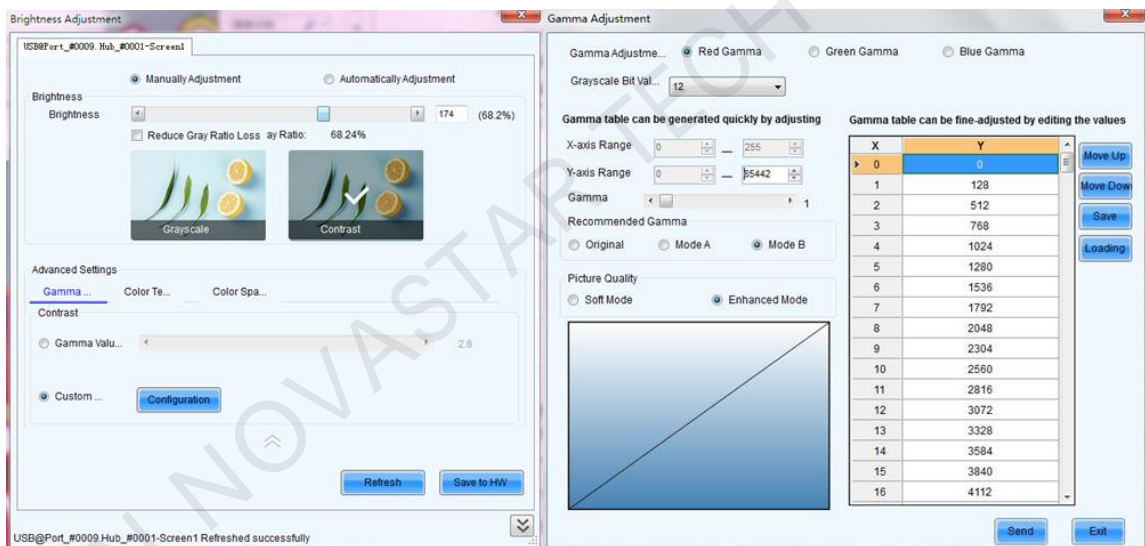

Note:

When the input bit depth is 8-bit, the individual gamma adjustment for RGB is realized by the AXs (V2.0) series receiving cards.

7.2 Operations on Web Page

The MCTRL660 PRO allows users to configure screens on a web page, making screen configuration much easier.

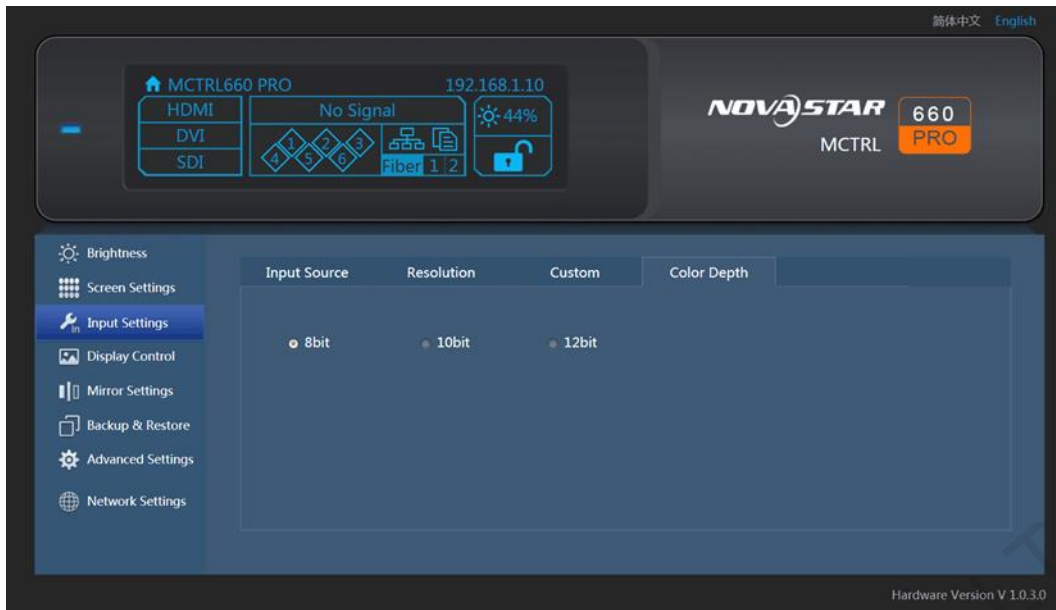
**Note:**

The operations on a web page are synchronized with the operations on the device. Operations not supported on a web page include **Advanced Settings > Load RCFG Files, Presettings, Inputs Backup, System Settings, Communication Settings > Communication Mode, and Working Mode.**

7.2.1 Environment Configuration

- Step 1 Connect the MCTRL660 PRO to PC (or a mobile device).
- Application 1: The MCTRL660 PRO and PC are connected with an Ethernet cable.
 - Application 2: The MCTRL660 PRO and PC (or mobile device) are connected to the same LAN via a router.
- Step 2 Connect the PC (or mobile device) and MCTRL660 PRO to the same LAN.
- Step 3 Obtain the IP address of the MCTRL660 PRO.
- Step 4 Enter the IP address in the address bar of the browser to access the operation page.

Note:

Google Chrome is recommended (You can also use Safari on iOS devices).

7.2.2 Applications

Application 1

The MCTRL660 PRO is connected to the PC with an Ethernet cable.



Application 2

The MCTRL660 PRO is connected to the PC (or mobile device) over LAN.

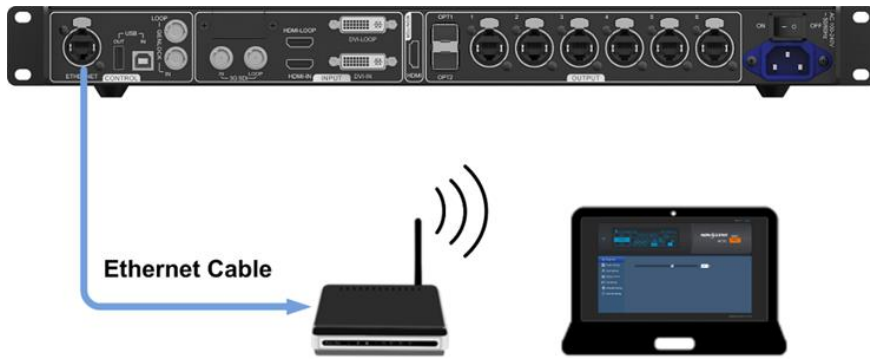

7.3 Software Operations on PC

7.3.1 NovaLCT

NovaLCT (V5.2.0 or later) communicates with the MCTRL660 PRO via USB cable, allowing for screen configuration, brightness adjustment, calibration, display control, monitoring, and more. For details, see *NovaLCT LED Configuration Tool for Synchronous Control System User Manual*.

Figure 7-1 NovaLCT

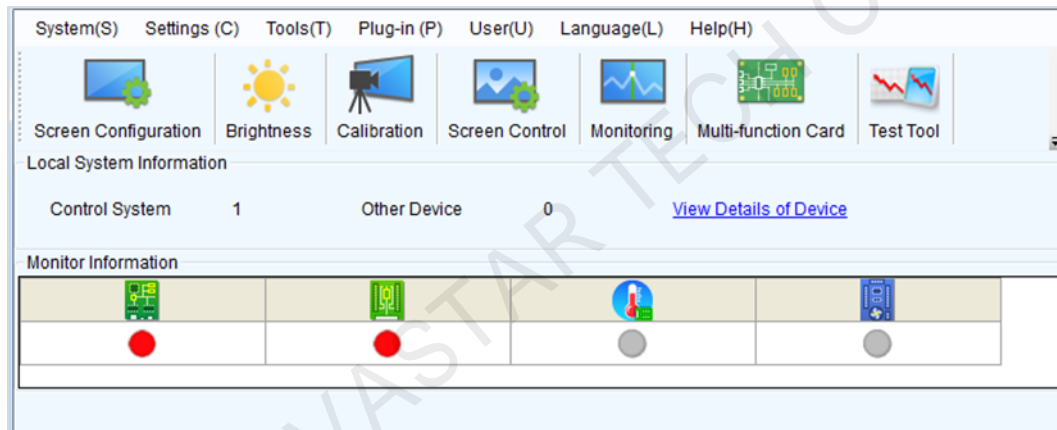

7.3.2 SmartLCT

SmartLCT (V3.2.0 or later) communicates with the MCTRL660 PRO via USB cable, allowing for building-block cabinet configuration, seam brightness adjustment, real-time monitoring, hot backup, and more. For details, see *SmartLCT User Manual*.

Figure 7-2 SmartLCT

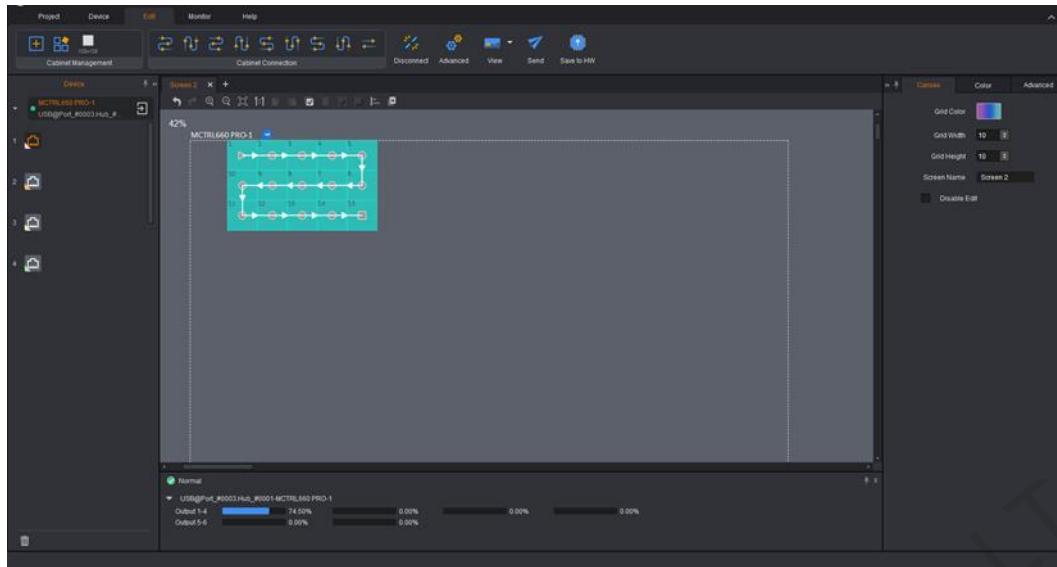

7.4 Firmware Update



7.4.1 NovaLCT

In NovaLCT, perform the following steps to update the firmware.

- Step 1 Run the NovaLCT. On the menu bar, go to **User > Advanced Synchronous System User Login**. Enter the password and click **Login**.
- Step 2 Type the secret code “**admin**” to open the program loading page.
- Step 3 Click **Browse**, select a program package, and click **Update**.

7.4.2 SmartLCT

In SmartLCT, perform the following steps to update the firmware.

- Step 1 Run SmartLCT and enter the V-Sender page.
- Step 2 In the properties area on the right, click  to enter the **Firmware Upgrade** page.
- Step 3 Click  to select the update program path.
- Step 4 Click **Update**.

7.5 Sending Card Name Customization

Customize the name of the sending card. This name and the IP address is displayed alternately on the front panel of the MCTRL660 PRO.

- Step 1 Run the NovaLCT software. On the menu bar, go to **User > Advanced Synchronous System User Login**. Enter the password and click **Login**.
- Step 2 Go to **Tools > Controller Cabinet Configuration File Import** to enter the controller cabinet configuration file importing page.

Figure 7-3 Home page

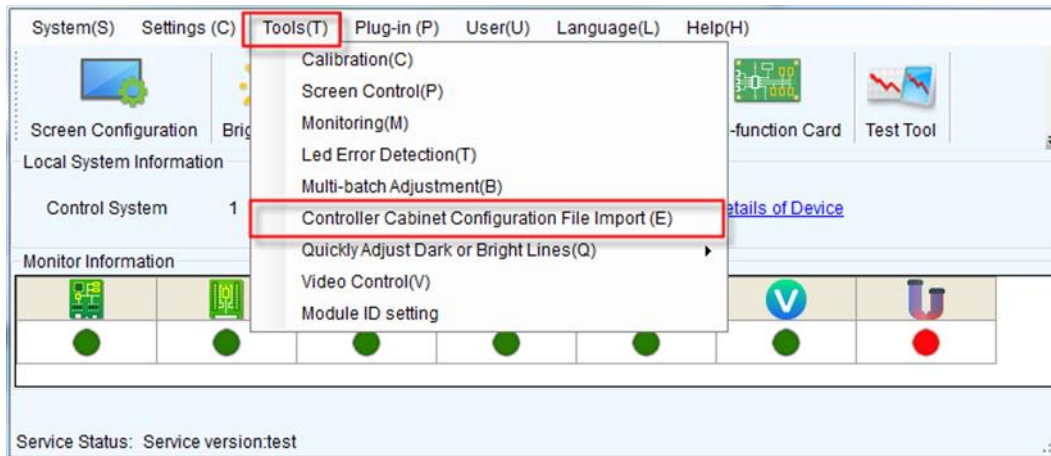

- Step 3 Under **Sending Card Name Setting**, select **Enable Naming** and click **Rename**. On the displayed **Rename** dialog box, enter a name and click **OK**.

Figure 7-4 Importing controller cabinet configuration file

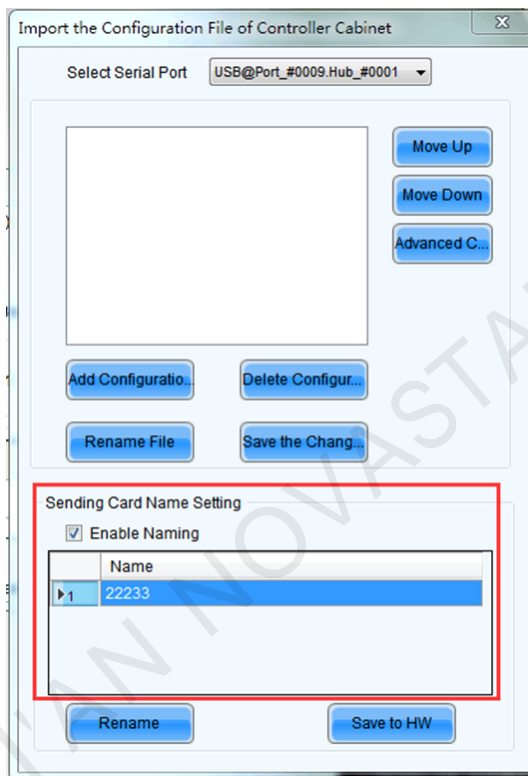

- Step 4 On the Controller Cabinet Configuration File Import page, click Save to HW.

8 Specifications

Electrical Specifications	Input voltage	100 V–240 V AC
	Rated power consumption	20 W
Operating Environment	Temperature	–20°C to +60°C
	Humidity	10% RH to 90% RH, non-condensing
Storage Environment	Temperature	–20°C to +70°C
	Humidity	10% RH to 90% RH, non-condensing
Physical Specifications	Dimensions	482.6 mm × 356.0 mm × 50.1 mm
	Weight	4.6 kg
Packing Information	Packing box	550 mm × 440 mm × 175 mm
	Carrying case	530 mm × 140 mm × 410 mm
	Accessories	1x Power cord 1x Ethernet cable 1x USB cable 1x HDMI cable 1x DVI cable

The amount of power consumption may vary depending on various factors such as product settings, usage, and environment.

Copyright © 2022 Xi'an NovaStar Tech Co., Ltd. All Rights Reserved.

No part of this document may be copied, reproduced, extracted or transmitted in any form or by any means without the prior written consent of Xi'an NovaStar Tech Co., Ltd.

Trademark

NOVA STAR is a trademark of Xi'an NovaStar Tech Co., Ltd.

Statement

Thank you for choosing NovaStar's product. This document is intended to help you understand and use the product. For accuracy and reliability, NovaStar may make improvements and/or changes to this document at any time and without notice. If you experience any problems in use or have any suggestions, please contact us via the contact information given in this document. We will do our best to solve any issues, as well as evaluate and implement any suggestions.

Official website
www.novastar.tech

Technical support
support@novastar.tech